

Rede

Leo

CATÁLOGO DE  
PERFIS  
DE ALUMÍNIO

Julho/2022



Incluindo  
**Sistema de  
Prateleiras Leo**



[www.leomadeiras.com.br](http://www.leomadeiras.com.br)

O mix completo de  
cores está disponível  
na plataforma

**promob**  
software solutions  
A 2020 Company

# PERFIS DE ALUMÍNIO LEO AGORA EM 19 CORES

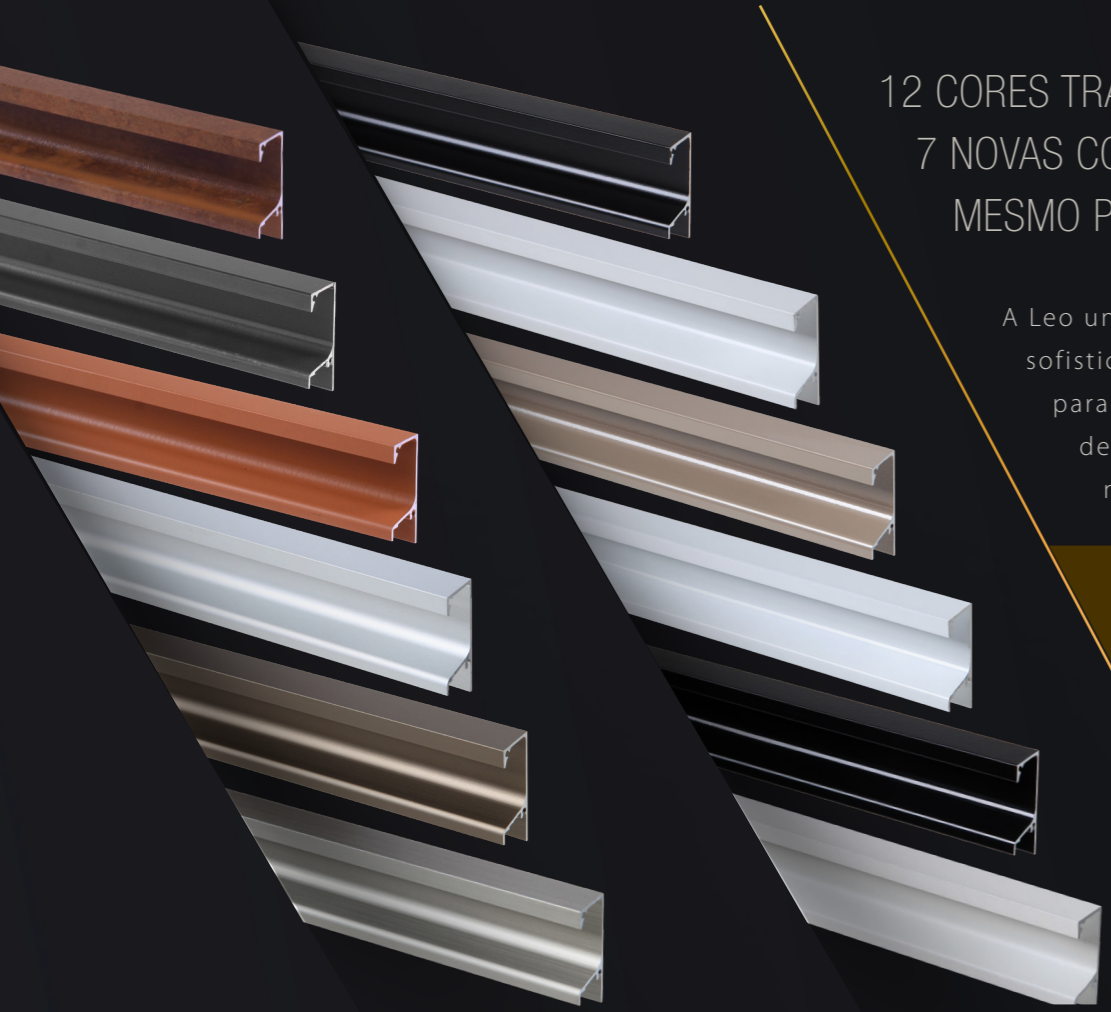

12 CORES TRADICIONAIS +  
7 NOVAS CORES NO  
MESMO PADRÃO DO MDF

A Leo uniu a elegância e a  
sofisticação em um só lugar  
para elevar a harmonização  
de portas e gavetas do  
móvel a um outro nível.

O mix completo de  
cores está disponível  
na plataforma

**promob**  
software solutions

A 2020 Company



COMBINAÇÃO PERFEITA  
A COR DO  
**PERFIL**  
NO MESMO PADRÃO DO  
**MDF**

## TRILHOS LEO

AGORA EM 18 CORES PARA A HARMONIZAÇÃO  
PERFEITA COM OS PERFIS E OS MDFS



## CAIXA EXPOSITORA

DE PERFIS LEO 2021 - 6ª EDIÇÃO  
5096332



<b>Carvalho Eterno</b> Essencial 5079882	<b>Elmo Suíço</b> Genuíno 5001321	<b>Fontana</b> Magma 5071464	<b>Rosa Glamour</b> Essencial 5063605	<b>Steel</b> Essencial 5071389
<b>Sal Rosa</b> Matt 5070172	<b>Carbono</b> Trama 5057357	<b>Cinza Sagrado</b> Essencial 5063597	<b>Ultramarino</b> Brilho Cristal 5079871	<b>Azul Petróleo</b> Matt 5059273

21 modelos de perfis  
e 10 padrões de MDF

**arauco**  
MELAMINA

**duratex**

**guararapes**

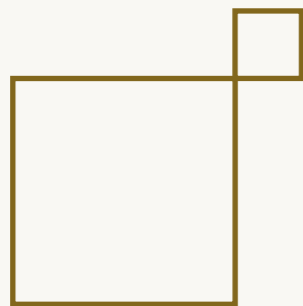

# SISTEMA PERFIL PRATELEIRA

Infinitas possibilidades em um único sistema



## TUTORIAL DE MONTAGEM

A Leo disponibiliza vídeos nos quais apresentamos detalhes e aplicações do Sistema de Prateleiras Leo, além de um **vídeo tutorial de montagem**. Nele você pode ver como é simples inovar e surpreender seus clientes.

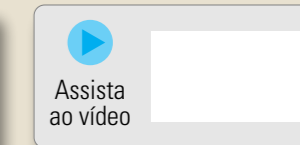
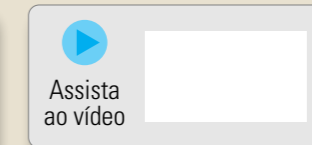
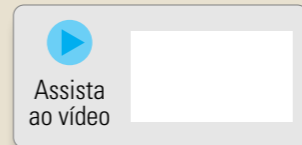

Se você quiser, confira também na página 46

### PERFIS

Disponíveis nas cores Grafite, Rosé, Aço Corten e Preto Fosco.

#### MV40 Tubo

Ideal para estruturas em geral

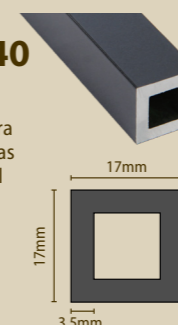

#### MV41 Tubo Led

Ideal para estruturas em geral, com uso da fita de Led

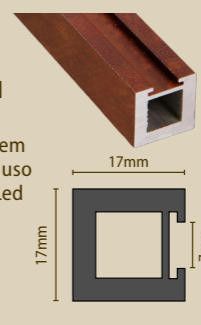

#### V42 Tubo Led com Apoio

Ideal para base de vidro

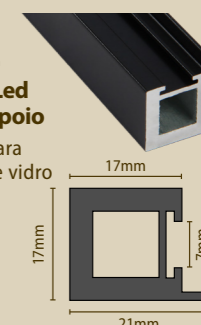

### ACESSÓRIOS

#### Conector Travessa

Pacote c/ 8 unidades e 16 Parafusos Philips M4x8mm



#### Conexão 45° Dupla

Pacote c/ 2 unidades e 4 Parafusos Philips M4x8mm



#### Conexão 45° Tripla

Pacote c/ 2 unidades e 6 Parafusos Philips M4x8mm



#### Gabarito

5102771 - Pacote c/ 1 unidade



#### Sapata Plástica

Pacote c/ 4 unidades



#### Fixa Teto

Pacote c/ 4 unidades e 4 Parafusos Philips M4x8mm

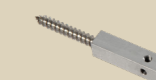

#### Emenda

Pacote c/ 2 unidades e 4 Parafusos Philips M4x8mm



Móveis Carneiro e Arquiteto Dani Amaral Arquitetos Associados

O mix completo de cores está disponível na plataforma



# PERFIS DE ALUMÍNIO LEO - ÍNDICE



Página 08

**M20**

Página 10

**M50**

Página 12

**M3000**

Página 14

**M13**

Página 16

**Cava**  
CV01 e CV02

Página 18

**M17**

Página 20

**M12** **V12P** **V07P**  
Pesado Pesado

Página 22

**M02** **V06L** **V07L** **V06P** **V07P**  
Leve Leve Pesado Pesado

Página 24

**M05** **V03** **V05**

Página 26

**M06**

Página 28

**M18**

**M16**  
Página 30

Página 32

**M15**

Página 33

**M08**

Página 34

**M14**

Página 35

**M01**

Página 35

**M03**

Página 35

**M04**

Página 36

**M02PB**  
Pegada Baixa

Página 37

**M07**

Página 37

**M11**

Página 39

**V08**

Página 40

**M10**

Página 40

**M09**

Página 41

**V09**

Página 42

**V10**

Página 50

**Trilho Superior**  
TLSD26  
TLSD28  
TLSD32

Página 50

**Trilho Inferior**  
TLID29  
TLID34  
TLID39

Página 51

**Dicas: Equipamentos para instalação dos perfis**

O mix completo de cores está disponível na plataforma

**promob**  
software solutions  
A 2020 Company

# M20

O Estilo Provençal inspira uma decoração romântica, móveis com feitiço mais delicado e contornos charmosos.



Assista ao vídeo

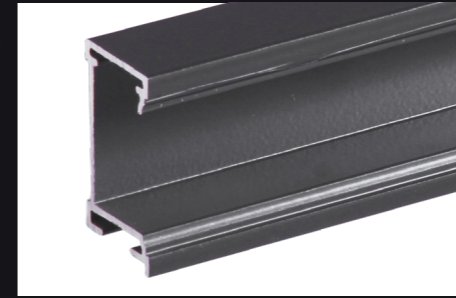
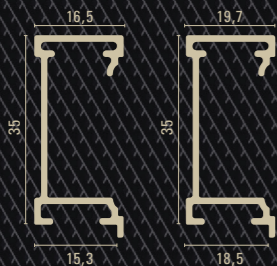

Perfil M20

A aplicação do perfil por suporte, sem furação aparente, proporciona elegância num design minimalista.

O uso da tampa alia beleza e segurança.



Tampa para Perfil M20



O Perfil M20 Leo é aplicado com o Suporte Perfil Leo M2015/2018 (5080463).

Na instalação do Suporte M20 é necessário respeitar a distância máxima de 50cm entre a fixação dos suportes.

7 NOVAS CORES que harmonizam com os padrões do MDF

12 CORES incluindo o tradicional padrão Alumínio

Cor	Perfil 15mm	Perfil 18mm	Tampa Vazada 15mm	Tampa Vazada 18mm
Ouro Perolizado	5100006	5100008	5100075	5100076
Azul Petróleo	5091104	5091116	5091227	5091233
Carbono	5091106	5091118	5091225	5091231
Cinza Sagrado	5091108	5091120	5091224	5091230
Rosa Glamour	5091110	5091122	5091228	5091234
Steel	5091112	5091124	5091229	5091235
Ultramarino	5091114	5091126	5091226	5091232
Aço Corten	5080483	5080503	5080586	5080599
Grafite	5080491	5080513	5080580	5080593
Rosé	5080501	5080523	5080582	5080595
Jateado	5080495	5080517	5080576	5080589
Bronze	5080489	5080509	5080584	5080597
Inox	5080493	5080515	5080585	5080598
Preto Fosco	5080499	5080521	5080579	5080592
Branco Fosco	5080487	5080507	5080581	5080594
Fendi	5080420	5080511	5080587	5080600
Branco Brilhante	5080485	5080505	5080578	5080591
Preto Brilhante	5080497	5080519	5080577	5080590
Branco TX	5080567	5080569	5080583	5080596
Cromado	-	-	5080575	5080588

Ouro Perolizado

Ultramarino

Cinza Sagrado

Carbono

Rosa Glamour

Steel

Azul Petróleo

Rosé

Preto Brilhante

Fendi

Branco Fosco

Bronze

Branco Brilhante

Inox

Preto Fosco

Jateado

Branco TX

Grafite

Aço Corten

O mix completo de cores está disponível na plataforma

**promob**  
software solutions  
A 2020 Company



# M50

M50 é um Perfil de corte reto, mas oferece a opção de tampas com cantos curvos, amenizando ou até mesmo evitando acidentes no dia a dia, além do pouco alumínio aparente, sem apresentar a fixação por parafuso.



Assista ao vídeo



Perfil M50

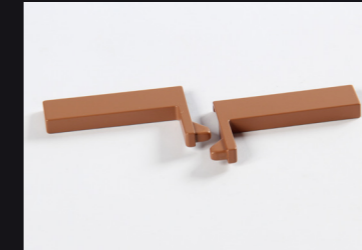

Tampa para Perfil M50

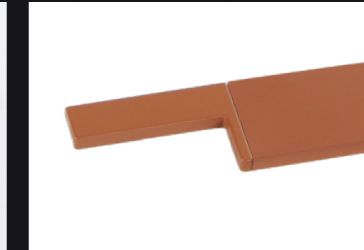

Perfil M50 com Tampa aplicada

A aplicação do perfil por suporte, sem furação aparente, proporciona elegância num design minimalista. O uso da tampa alia beleza e segurança.



O Perfil M50 Leo é aplicado com o Suporte Perfil Leo M5015/5018 (5080463).

Na instalação do Suporte M50 é necessário respeitar a distância máxima de 50cm entre a fixação dos suportes.

Cor	Perfil 15mm	Perfil 18mm	Tampa 15mm	Tampa 18mm
Ouro Perolizado	5100010	5100012	5100077	5100078
Azul Petróleo	5091128	5091140	5091215	5091221
Carbono	5091130	5091142	5091213	5091219
Cinza Sagrado	5091132	5091144	5091212	5091218
Rosa Glamour	5091134	5091146	5091216	5091222
Steel	5091137	5091149	5091214	5091223
Ultramarino	5091138	5091150	5091217	5091220
Aço Corten	5080525	5080545	5080612	5080625
Grafite	5080535	5080555	5080606	5080619
Rosé	5080418	5080565	5080608	5080621
Jateado	5080539	5080559	5080602	5080615
Bronze	5080531	5080551	5080610	5080623
Inox	5080537	5080557	5080611	5080624
Preto Fosco	5080543	5080563	5080605	5080618
Branco Fosco	5080529	5080549	5080607	5080620
Fendi	5080533	5080553	5080613	5080626
Branco Brilhante	5080527	5080547	5080604	5080617
Preto Brilhante	5080541	5080561	5080603	5080616
Branco TX	5080571	5080573	5080609	5080622
Cromado	-	-	5080601	5080614

7 NOVAS CORES que harmonizam com os padrões do MDF

12 CORES incluindo o tradicional padrão Alumínio

Ouro Perolizado

Ultramarino

Cinza Sagrado

Carbono

Rosa Glamour

Steel

Azul Petróleo

Rosé

Preto Brilhante

Fendi

Branco Fosco

Bronze

Branco Brilhante

Inox

Preto Fosco

Jateado

Branco TX

Grafite

Aço Corten

O mix completo de cores está disponível na plataforma

**promob**  
software solutions  
A 2020 Company



# M3000

Único modelo de perfil para espessuras de portas e gavetas de 15 a 25mm, inclusive portas de vidro.

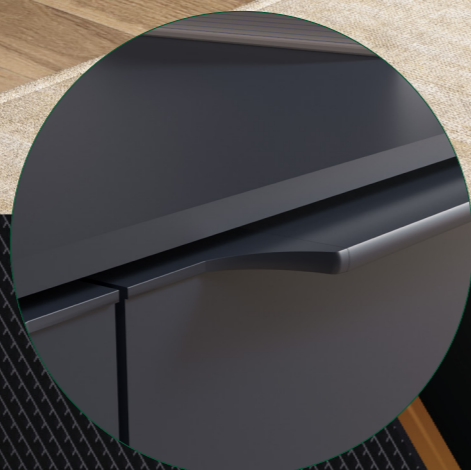

Perfil M3000  
Para MDF de 15mm a 25mm

O Perfil nesse modelo oferece a vantagem de, em uma única barra, poder confeccionar puxadores para portas de 15 a 25mm.

O que define a espessura da porta são suas opções de tampas.

- Tampa para chapa de 15mm
- Tampa para chapa de 18mm
- Tampa Reta para chapa de 15mm
- Tampa Reta para chapa de 18mm
- Tampa Slim para chapas de 20 a 25mm

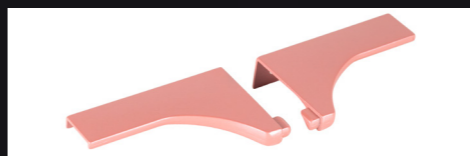

Tampa para Perfil M3000  
Para MDF de 15mm e 18mm



Tampa Slim para Perfil M3000  
Única para MDF de 15 a 25mm



Perfil M3000 com Tampa



Perfil M3000 com Tampa Slim



Tampa Reta para Perfil M3000 para  
MDF de 15mm e 18mm

7 NOVAS  
CORES  
que harmonizam  
com os padrões  
do MDF

12 CORES  
incluindo o  
tradicional  
padrão  
Alumínio

Cor	Perfil	Tampa 15mm	Tampa Reta 15mm	Tampa 18mm	Tampa Reta 18mm	Tampa Slim
Ouro Perolizado	5100004	5100072	5102754	5100073	5102577	5100074
Azul Petróleo	5090841	5090748	5102749	5090754	5102572	5090742
Carbono	5090837	5090746	5102742	5090752	5102762	5090740
Cinza Sagrado	5090835	5090745	5102741	5090751	5102761	5090739
Rosa Glamour	5090833	5090749	5102751	5090755	5102574	5090743
Steel	5090839	5090750	5102752	5090756	5102575	5090744
Ultramarino	5090831	5090747	5102748	5090753	5102571	5090741
Aço Corten	5080313	5080453	-	5080456	-	5080450
Grafite	5080311	5080451	5102740	5080454	5102760	5080448
Rosé	5080352	5080452	5102744	5080455	5102764	5080449
Jateado	5068641	5070313	5102736	5070323	5102756	5073590
Bronze	5068643	5070319	5102747	5070329	5102570	5073596
Inox	5068642	5070320	5102750	5070330	5102573	5073597
Preto Fosco	5068648	5070316	5102739	5070326	5102759	5073593
Branco Fosco	5068647	5070317	5102743	5070327	5102763	5073594
Fendi	5068644	5070321	5102753	5070331	5102576	5073598
Branco Brilhante	5068646	5070315	5102738	5070325	5102758	5073592
Preto Brilhante	5068645	5070314	5102737	5070324	5102757	5073591
Branco TX	5068657	5070318	5102746	5070328	5102766	5073595
Cromado	-	5070312	5102735	5070322	5102755	5073589

Ouro Perolizado

Ultramarino

Cinza Sagrado

Carbono

Rosa Glamour

Steel

Azul Petróleo

Rosé

Preto Brilhante

Fendi

Branco Fosco

Bronze

Branco Brilhante

Inox

Preto Fosco

Jateado

Branco TX

Grafite

Aço Corten

O mix completo de cores está disponível na plataforma

**promob**  
software solutions  
A 2020 Company



# M13

Perfil clássico que não sai de linha.

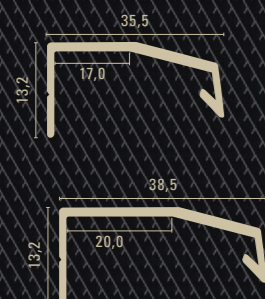

Perfil M13

O Perfil M13, já conhecido no tradicional padrão alumínio, agora disponível em 18 cores do portfólio Leo.

Disponível para chapas de 15 e 18mm, com a sua tampa que se encaixa na gaveta.

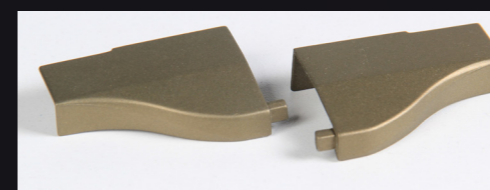

Tampa para Perfil M13



Perfil M13 com Tampa



Tampa para Perfil M13 Acabamento Cromado

Cor	Perfil 15mm	Perfil 18mm	Tampa 15mm	Tampa 18mm
Ouro Perolizado	5100014	5100016	5100064	5100065
Azul Petróleo	5091032	5091044	5091191	5091197
Carbono	5091034	5091046	5091189	5091195
Cinza Sagrado	5091036	5091048	5091188	5091194
Rosa Glamour	5091038	5091050	5091192	5091198
Steel	5091041	5091053	5091193	5091199
Ultramarino	5091042	5091054	5091190	5091196
Aço Corten	5082199	5082217	5082116	5082126
Grafite	5082209	5082227	5082123	5082130
Rosé	5082215	5082233	5082125	5082133
Jateado	5056536	5056530	5058672	5058675
Bronze	5056540	5056534	5058670	5058673
Inox	5056538	5056532	5058671	5058674
Preto Fosco	5082213	5082231	5082120	5082132
Branco Fosco	5082203	5082221	5082118	5082127
Fendi	5082207	5082225	5082119	5082129
Branco Brilhante	5082201	5082219	5082117	5082121
Preto Brilhante	5082211	5082229	5082124	5082131
Branco TX	5082205	5082223	5082122	5082128
Cromado	-	-	5057325	5057326

7 NOVAS CORES que harmonizam com os padrões do MDF

12 CORES incluindo o tradicional padrão Alumínio

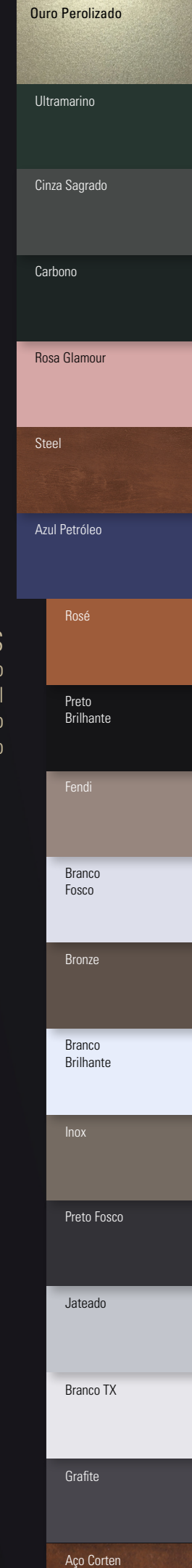

O mix completo de cores está disponível na plataforma

**promob**  
software solutions  
A 2020 Company





# PERFIL CAVA LEO



7 NOVAS  
CORES  
que harmonizam  
com os padrões  
do MDF

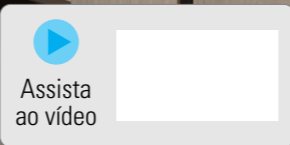

Perfil Cava 01



Perfil Cava 02

O Perfil da Linha Cava é uma ótima opção para aplicações em móveis de cozinha, deixando o aspecto mais limpo, alinhando as atuais tendências do mobiliário. A gaveta ou porta torna-se o próprio puxador.



Tampa para Perfil Cava 01



Tampa para Perfil Cava 02



Suporte Plástico para Perfis Cava 01 e Cava 02 5065065

12 CORES  
incluindo o  
tradicional  
padrão  
Alumínio

Cor	Perfil Cava 01	Perfil Cava 02	Tampa Vazada Cava 01	Tampa Vazada Cava 02
Ouro Perolizado	5100018	5100020	5100070	5100071
Azul Petróleo	5090900	5090912	5093411	5093417
Carbono	5090902	5090914	5093409	5093415
Cinza Sagrado	5090904	5090916	5093408	5093414
Rosa Glamour	5090906	5090918	5093412	5093418
Steel	5090908	5090920	5093413	5093419
Ultramarino	5090910	5090922	5093410	5093416
Aço Corten	5080289	5080293	5080459	5080462
Grafite	5080287	5080291	5080457	5080460
Rosé	5080340	5080342	5080458	5080461
Jateado	5064457	5064465	5065041	5065050
Bronze	5064459	5064467	5065046	5065055
Inox	5064458	5064466	5065047	5065056
Preto Fosco	5064464	5064472	5065044	5065053
Branco Fosco	5064463	5064471	5065045	5065054
Fendi	5064460	5064468	5065048	5065057
Branco Brilhante	5064462	5064470	5065043	5065052
Preto Brilhante	5064461	5064469	5065042	5065051
Branco TX	5067438	5067440	5077787	5077788
Cromado	-	-	5065040	5065049



## Tutorial de aplicação

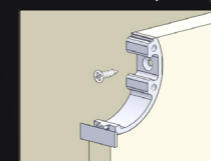

Suporte Plástico para Perfis Cava 01

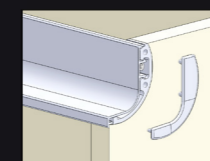

Aplicação do perfil no suporte

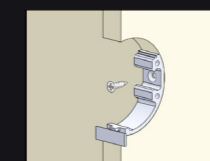

Suporte Plástico para Perfis Cava 02

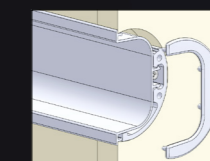

Aplicação do perfil no suporte

Ouro Perolizado

Ultramarino

Cinza Sagrado

Carbono

Rosa Glamour

Steel

Azul Petróleo

Rosé

Preto Brilhante

Fendi

Branco Fosco

Bronze

Branco Brilhante

Inox

Preto Fosco

Jateado

Branco TX

Grafite

Aço Corten

# M17

O Perfil M17 foi desenvolvido para ser utilizado com fita de borda de 35mm, oferecendo um perfeito acabamento estético ao móvel.

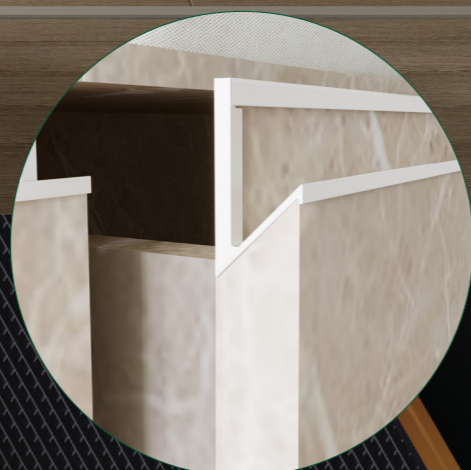
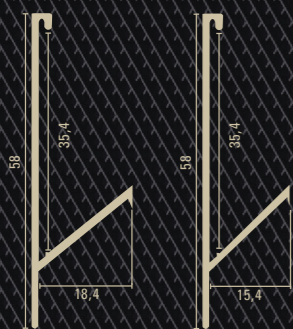

Perfil M17



Tampa para Perfil M17

Para uso com a aplicação da fita de borda no perfil, deixando o alumínio minimalista. As tampas acompanham as cores dos perfis, dando um acabamento PERFEITO. Para MDF de 15 e 18mm.

Cor	Perfil 15mm	Perfil 18mm	Tampa Vazada 15mm	Tampa Vazada 18mm
Ouro Perolizado	5100022	5100024	5100066	5100067
Azul Petróleo	5091080	5091092	5091203	5091209
Carbono	5091082	5091094	5091201	5091207
Cinza Sagrado	5091084	5091096	5091200	5091206
Rosa Glamour	5091086	5091098	5091204	5091210
Steel	5091089	5091101	5091205	5091211
Ultramarino	5091090	5091102	5091202	5091208
Aço Corten	5080305	5080309	5080429	5080432
Grafite	5080303	5080307	5080427	5080430
Rosé	5080348	5080350	5080428	5080431
Jateado	5057019	5057301	5062380	5062383
Bronze	5060293	5060319	5071953	5071954
Inox	5060291	5060325	5071955	5071956
Preto Fosco	5060297	5060323	5077781	5077782
Branco Fosco	5060295	5060321	5062381	5062384
Fendi	5082243	5082249	5082137	5082143
Branco Brilhante	5082241	5082247	5082135	5082142
Preto Brilhante	5082245	5082251	5082138	5082144
Branco TX	5067446	5067448	5067896	5067897
Cromado	-	-	5062379	5062382

7 NOVAS CORES que harmonizam com os padrões do MDF

12 CORES incluindo o tradicional padrão Alumínio

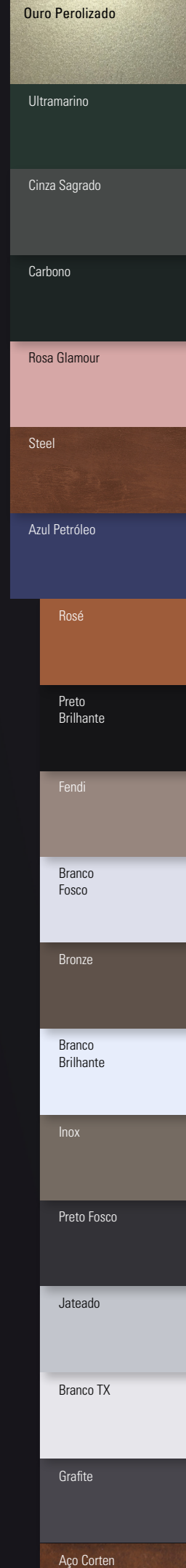

# M12, V12 com V07 Pesado

Harmonize o perfil M12 com os perfis para vidro V12 e V07.



Assista ao vídeo



Perfil M12



Tampa para Perfil M12

O uso da tampa alia beleza e segurança.



Suporte para Perfil M12 5057299

A aplicação do perfil por suporte, sem furação aparente, proporciona elegância num design minimalista.

7 NOVAS CORES que harmonizam com os padrões do MDF

12 CORES incluindo o tradicional padrão Alumínio

Cor	Perfil M12 15mm	Perfil M12 18mm	Tampa Vazada 15mm	Tampa Vazada 18mm	Perfil V12 Pesado	Tampa Vazada V12	Perfil V07 Pesado
					Vidro 4mm Para portas de até 0,80 x 2,50		
Ouro Perolizado	5100026	5100028	5100062	5100063	5101550	5101549	5100036
Azul Petróleo	5091008	5091020	5091179	5091185	5090888	5093405	5090829
Carbono	5091010	5091022	5091177	5091183	5090890	5093403	5090825
Cinza Sagrado	5091012	5091024	5091176	5091182	5090892	5093402	5090823
Rosa Glamour	5091014	5091026	5091180	5091186	5090894	5093406	5090821
Steel	5091017	5091029	5091181	5091187	5090896	5093407	5090827
Ultramarino	5091018	5091030	5091178	5091184	5090898	5093404	5090819
Aço Corten	5080301	5080297	5080444	5080447	5080337	5080441	5080331
Grafite	5080299	5080295	5080442	5080445	5080333	5080439	5080327
Rosé	5080344	5080346	5080443	5080446	5080335	5080440	5080329
Jateado	5056524	5056522	5057320	5057321	5062315	5062373	5058278
Bronze	5056528	5056520	5057317	5057322	5062319	5062376	5058282
Inox	5056526	5056518	5057319	5057323	5062317	5062377	5058280
Preto Fosco	5082191	5082197	5082136	5082141	5083627	5084016	5062369
Branco Fosco	5082187	5082193	5082134	5082139	5083629	5084017	5062367
Fendi	5060950	5060956	5061009	5061012	5062321	5062378	5062345
Branco Brilhante	5060948	5060954	5061008	5061011	5062323	5062375	5062347
Preto Brilhante	5060952	5060958	5061007	5061010	5062325	5062374	5062349
Branco TX	5082189	5082195	5082115	5082140	5083631	5084018	5067456
Cromado	-	-	5057318	5057324	-	5062372	-

## LANÇAMENTO



Esquadreta Pesada Leo de 41mm para Perfil de Vidro com gabarito 5095109



Esquadreta Pesada Leo de 41mm para Perfil de Vidro sem gabarito 5095110



Baguete Adesiva para Perfis de Vidro 5095468

O mix completo de cores está disponível na plataforma

**promob**  
software solutions  
A 2020 Company



# M02, V06 com V07



Harmonize o perfil M02 com os perfis para vidro V06 e V07.

7 NOVAS CORES que harmonizam com os padrões do MDF



Perfil M02

O tradicional Perfil M02 do mercado, agora disponível em 19 cores.



Tampa Slim para Perfil M02

Sua tampa slim oferece um acabamento perfeito, oferecendo beleza e segurança ao móvel.

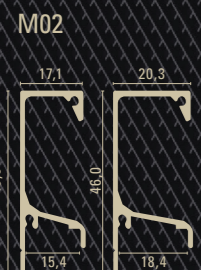

Esquadreta Pesada 5000923

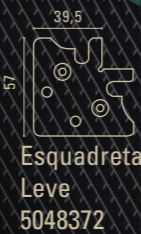

Esquadreta Leve 5048372

Cor	Perfil M02 15mm	Perfil M02 18mm	Tampa Slim 15mm	Tampa Slim 18mm	Para portas de até 0,80 x 2,20		Para portas de até 0,80 x 2,50	
					Perfil V06 Leve	Perfil V07 Leve	Perfil V06 Pesado	Perfil V07 Pesado
Ouro Perolizado	5100000	5100002	5100068	5100069	5100030	5100034	5100032	5100036
Azul Petróleo	5090793	5090805	5090736	5090760	5093432	5093444	5090817	5090829
Carbono	5090789	5090801	5090734	5090758	5093434	5093446	5090813	5090825
Cinza Sagrado	5090787	5090799	5090733	5090757	5093436	5093448	5090811	5090823
Rosa Glamour	5090785	5090797	5090737	5090761	5093438	5093450	5090809	5090821
Steel	5090791	5090803	5090738	5090762	5093440	5093452	5090815	5090827
Ultramarino	5090783	5090795	5090735	5090759	5093442	5093454	5090807	5090819
Aço Corten	5080219	5080224	5080435	5080438	5080325	5080319	5080637	5080331
Grafite	5080214	5080215	5080433	5080436	5080321	5080315	5080633	5080327
Rosé	5080217	5080222	5080434	5080437	5080323	5080317	5080635	5080329
Jateado	5056450	5056460	5063205	5063214	5040436	5040455	5058272	5058278
Bronze	5056458	5056468	5063210	5063219	5071769	5071753	5058276	5058282
Inox	5056452	5056462	5063211	5063220	5071767	5071751	5058274	5058280
Preto Fosco	5056456	5056466	5063208	5063217	5083633	5071759	5062365	5062369
Branco Fosco	5056454	5056464	5063209	5063218	5071771	5071757	5062363	5062367
Fendi	5060938	5060944	5063212	5063221	5071773	5071763	5062339	5062345
Branco Brilhante	5060936	5060942	5063207	5063216	5083635	5071761	5062341	5062347
Preto Brilhante	5060940	5060946	5063206	5063215	5083637	5071765	5062343	5062349
Branco TX	5066823	5066825	5067405	5067406	5071951	5071755	5067454	5067456
Cromado	-	-	5063204	5063213	-	-	-	-

Tampas Fechadas - 5057303 15mm / 5057310 18mm

12 CORES incluindo o tradicional padrão Alumínio

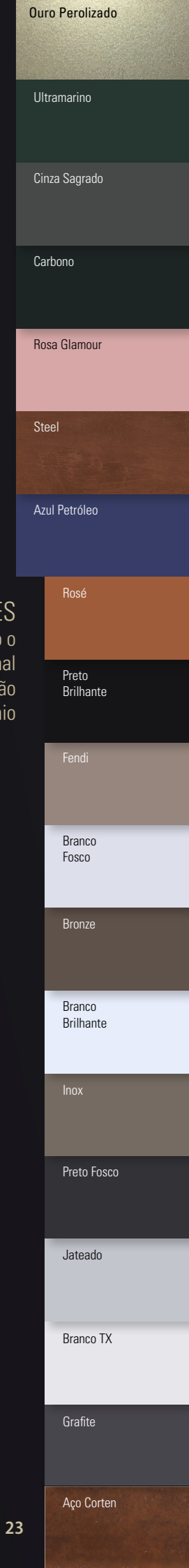

## LANÇAMENTO



Esquadreta Pesada Leo de 41mm para Perfil de Vidro com gabarito 5095109



Esquadreta Leve Leo de 41mm para Perfil de Vidro sem gabarito 5095110



Baguete Adesiva para Perfis de Vidro 5059468

O mix completo de cores está disponível na plataforma



# M05, V03 e V05

Ideal para puxador e requadro total das portas de vidro.



Perfil M05

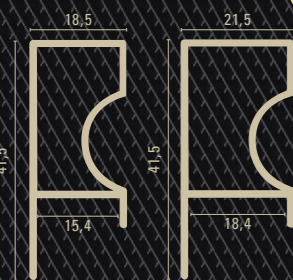

Perfil para Vidro V03

Perfil para Vidro V05

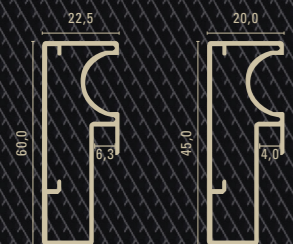

Esquadreta Pesada 5000923

7 NOVAS CORES que harmonizam com os padrões do MDF



Os Perfis M05 para chapas de 15 e 18mm, com o auxílio da esquadreta, fazem o **perfeito contorno em portas** dos mais variados tamanhos.

Desenvolvido para ser utilizado com sistemas de porta de correr, principalmente sistemas para painéis, pois oferece opção de uso para abertura em toda a sua extensão.



Perfil para Vidro V03

5040457 - para Vidro de 6mm - Jateado



Perfil para Vidro V05

5040456 - para Vidro de 4mm - Jateado

Também dispomos dos modelos V03 para vidro de 6mm e V05 para vidro de 4mm.

12 CORES incluindo o tradicional padrão Alumínio

Cor	Perfil 15mm	Perfil 18mm
Ouro Perolizado	5100038	5100040
Azul Petróleo	5090924	5090936
Carbono	5090926	5090938
Cinza Sagrado	5090928	5090940
Rosa Glamour	5090930	5090942
Steel	5090933	5090945
Ultramarino	5090934	5090946
Aço Corten	5082145	5082151
Grafite	5082147	5082153
Rosé	5082149	5082155
Jateado	5040452	5040451
Bronze	5073656	5073722
Inox	5073650	5073728
Preto Fosco	5073654	5073726
Branco Fosco	5073652	5073724
Fendi	5073660	5073734
Branco Brilhante	5073658	5073732
Preto Brilhante	5073662	5073736
Branco TX	5073664	5073730



Baguete Adesiva para Perfis de Vidro 5059468

### LANÇAMENTO



Esquadreta Pesada Leo de 41mm para Perfil de Vidro com gabarito 5095109



Esquadreta Pesada Leo de 41mm para Perfil de Vidro sem gabarito 5095110

Ouro Perolizado

Ultramarino

Cinza Sagrado

Carbono

Rosa Glamour

Steel

Azul Petróleo

Rosé

Preto Brilhante

Fendi

Branco Fosco

Bronze

Branco Brilhante

Inox

Preto Fosco

Jateado

Branco TX

Grafite

Aço Corten

O mix completo de cores está disponível na plataforma

**promob**  
software solutions  
A 2020 Company



# M06

Firmeza na pegada e excelente combinação com projetos modernos.

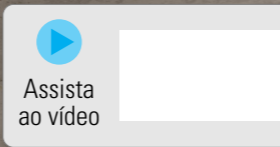

O tradicional Perfil M06, utilizado como puxador em todo comprimento da porta, agora disponível em 19 cores do Portfólio Leo para chapas de 15 a 25mm.

Cor	Perfil 15mm	Perfil 18mm	Perfil 20mm	Perfil 22mm	Perfil 25mm
Ouro Perolizado	5100042	5100044	5100046	5100048	5099992
Azul Petróleo	5090948	5090960	5090972	5090984	5099990
Carbono	5090950	5090962	5090974	5090986	5099988
Cinza Sagrado	5090952	5090964	5090976	5090988	5099984
Rosa Glamour	5090954	5090966	5090978	5090990	5099982
Steel	5090957	5090969	5090980	5090993	5099986
Ultramarino	5090958	5090970	5090982	5090994	5099980
Aço Corten	5082157	5082163	5082169	5082175	5099976
Grafite	5082159	5082165	5082171	5082177	5099974
Rosé	5082161	5082167	5082173	5082179	5099972
Jateado	5068659	5056504	5056498	5056939	5099956
Bronze	5068661	5071749	5056502	5073760	5099960
Inox	5068660	5056506	5056500	5073766	5099958
Preto Fosco	5068666	5060915	5073758	5073764	5099970
Branco Fosco	5068665	5073740	5073756	5073762	5099968
Fendi	5068662	5073744	5073750	5073772	5099962
Branco Brilhante	5068664	5073742	5073748	5073770	5099966
Preto Brilhante	5068663	5073746	5073752	5073774	5099964
Branco TX	5068675	5073738	5073754	5073768	5099978

7 NOVAS CORES que harmonizam com os padrões do MDF

12 CORES incluindo o tradicional padrão Alumínio

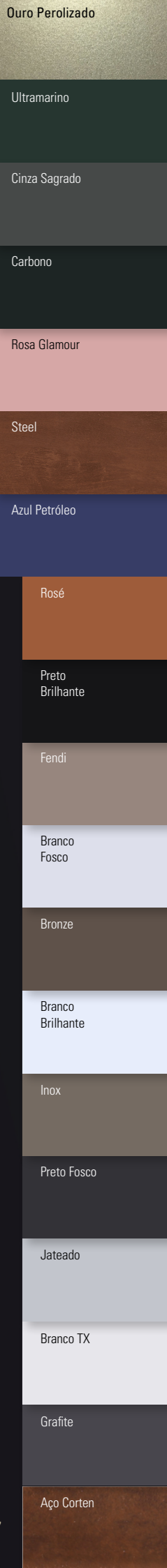

# M18

Perfil de topo e acabamento com grande variedade de cores.



7 NOVAS CORES que harmonizam com os padrões do MDF

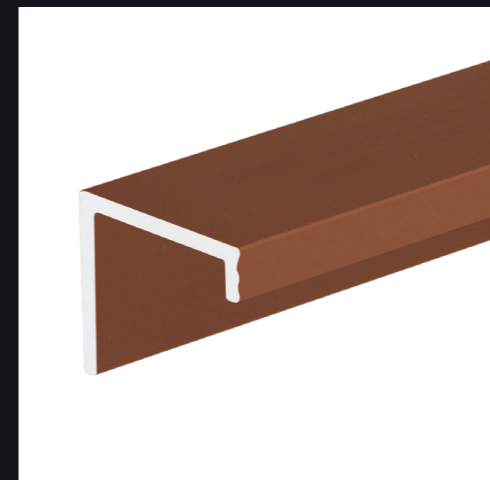

O Perfil M18 é ideal para substituir a fita de borda com o charme e a resistência do alumínio, oferecendo infinitas combinações com os outros perfis Leo. Pode ser instalado com parafusos ou com Cola Tudo Transparente Leo.

Cor	Perfil 15mm	Perfil 18mm
Ouro Perolizado	5100050	5100052
Azul Petróleo	5091164	5093420
Carbono	5091166	5093422
Cinza Sagrado	5091168	5093424
Rosa Glamour	5091170	5093426
Steel	5091172	5093428
Ultramarino	5091174	5093430
Aço Corten	5082259	5082265
Grafite	5082261	5082267
Rosé	5082263	5082269
Jateado	5057100	5057101
Bronze	5060301	5060309
Inox	5060299	5060307
Preto Fosco	5060305	5060313
Branco Fosco	5060303	5060311
Fendi	5062355	5062361
Branco Brilhante	5062351	5062357
Preto Brilhante	5062353	5062359
Branco TX	5067450	5067452

12 CORES incluindo o tradicional padrão Alumínio

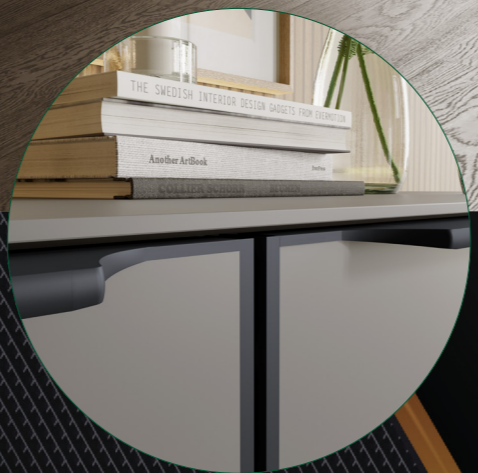
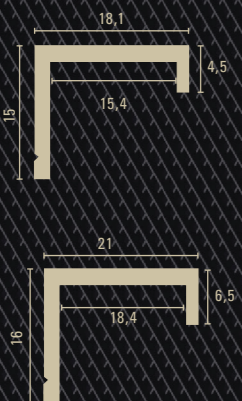
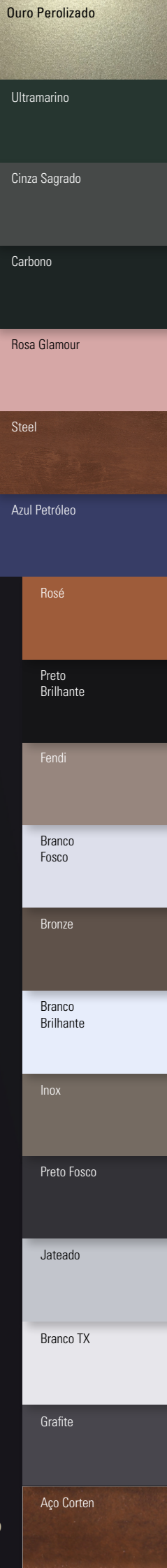

# M16

Beleza e sofisticação na junção de MDF.

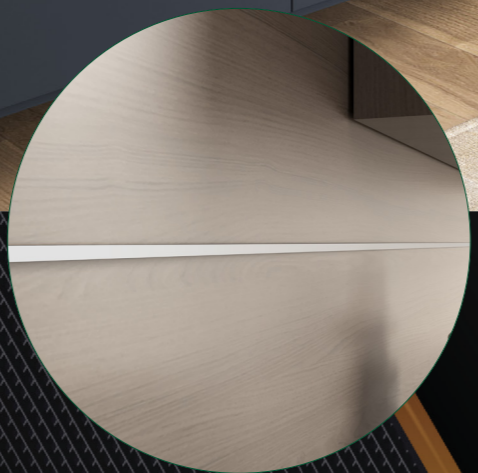
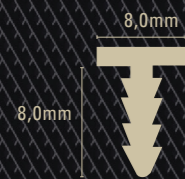

**Quer um detalhe no seu projeto?**

**Quer ocultar emendas de fórmica ou outros revestimentos?**

Utilize o Perfil M16. Sua instalação se dá através de um rasgo (de 7 a 8mm), podendo ser feito por Serra Esquadrejadeira SEL1900i Leo (5063704 - Monofásico ou 5063705 - Trifásico).

Recomenda-se o uso da Cola Tudo Transparente Leo para uma fixação efetiva (5071154).

O rasgo no MDF deve ser feito na Serra Esquadrejadeira ou Tupia Manual.

Cor	Perfil 8mm
Ouro Perolizado	5100054
Azul Petróleo	5091152
Carbono	5091154
Cinza Sagrado	5091156
Rosa Glamour	5091160
Steel	5091158
Ultramarino	5091162
Aço Corten	5082253
Grafite	5082255
Rosé	5082257
Jateado	5056935
Bronze	5058788
Inox	5073708
Preto Fosco	5073712
Branco Fosco	5073710
Fendi	5073718
Branco Brilhante	5073716
Preto Brilhante	5073720
Branco TX	5073714

7 NOVAS CORES que harmonizam com os padrões do MDF

12 CORES incluindo o tradicional padrão Alumínio

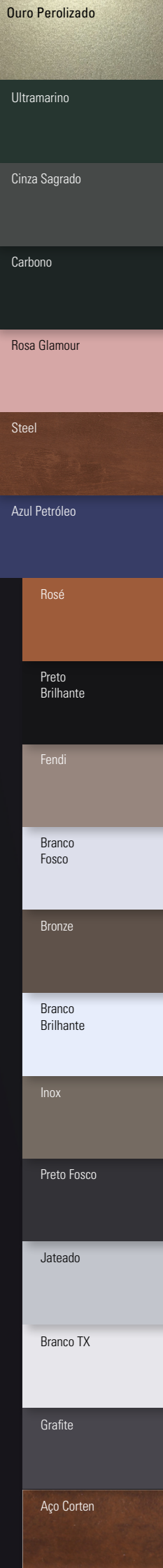



# M15

Valoriza os padrões unicores e madeirados do móvel.



O Perfil M15 tem a sua instalação feita no topo do MDF através de um rasgo realizado com a Tupia Manual 3709 06mm ¼" Makita (utilizar as hastes de 6mm serra para debrum - 5056998 e a serra debrum 3x40mm - 5056996).

Essa forma de aplicação elimina o uso de parafuso, deixando menos alumínio aparente, pois a fita de borda oculta até o rasgo.



Cor	Perfil 18mm
Ouro Perolizado	5100056
Azul Petróleo	5091068
Carbono	5091070
Cinza Sagrado	5091072
Rosa Glamour	5091074
Steel	5091077
Ultramarino	5091078
Aço Corten	5082235
Grafite	5082237
Rosé	5082239
Jateado	5056933
Bronze	5073668
Inox	5073666
Preto Fosco	5073672
Branco Fosco	5073670
Fendi	5073678
Branco Brilhante	5073676
Preto Brilhante	5073680
Branco TX	5073674

# M08

Versatilidade para os mais diversos ambientes e projetos.

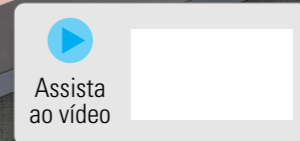
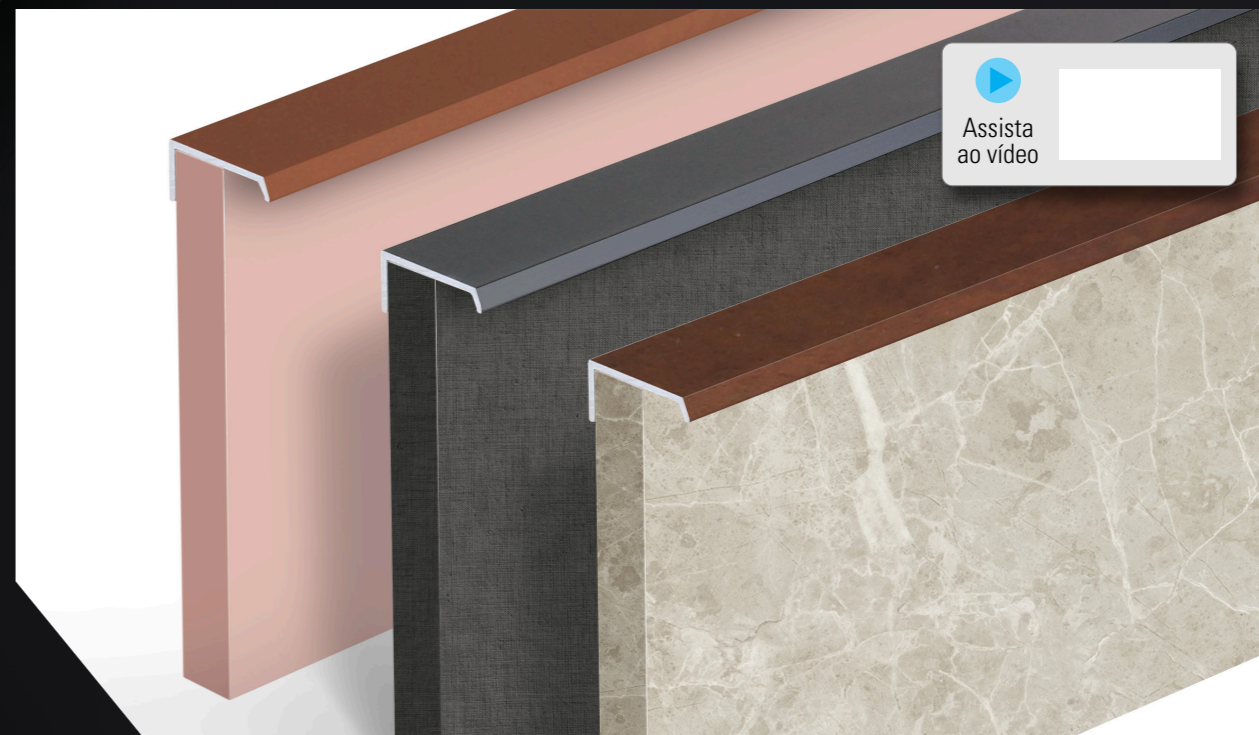

A Rede Leo agora disponibiliza o tradicional Perfil M08, para chapa de 18mm, em todas as cores do seu portfólio.

A versatilidade desse perfil valoriza seu projeto, pois ele pode ser utilizado em portas e gavetas, promovendo uma harmonia.



Cor	Perfil 18mm
Ouro Perolizado	5100058
Azul Petróleo	5090996
Carbono	5090998
Cinza Sagrado	5091000
Rosa Glamour	5091002
Steel	5091004
Ultramarino	5091006
Aço Corten	5082181
Grafite	5082183
Rosé	5082185
Jateado	5056510
Bronze	5073694
Inox	5070404
Preto Fosco	5073698
Branco Fosco	5073696
Fendi	5073704
Branco Brilhante	5073702
Preto Brilhante	5073706
Branco TX	5073700

O mix completo de cores está disponível na plataforma

**promob**  
software solutions  
A 2020 Company

# M14

Perfil versátil, que pode ser aplicado em MDF ou vidro.

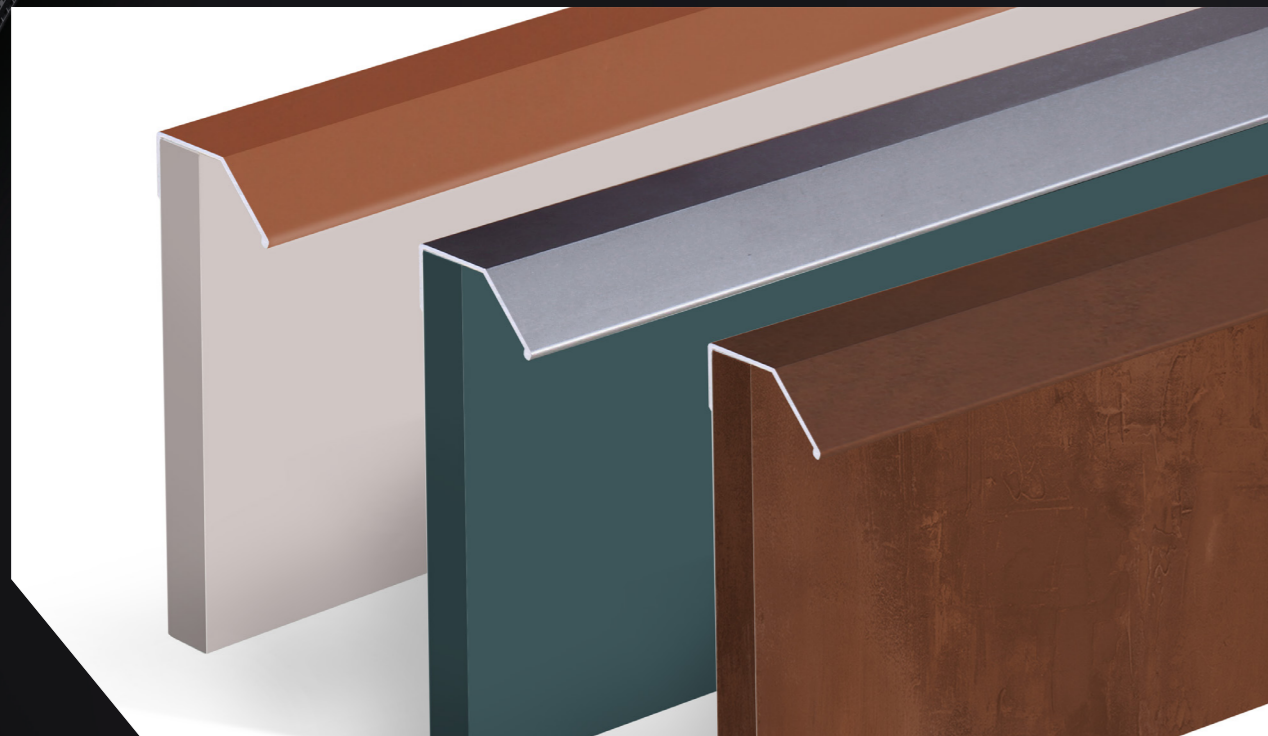

## Harmonize o perfil M14 com o perfil para vidro V07

A Rede Leo agora disponibiliza o tradicional Perfil M14, para chapas de madeira ou portas de alumínio, em todas as cores do seu portfólio.

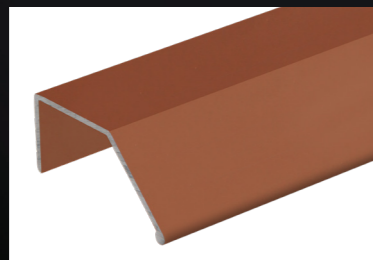

Cor	Perfil M14 22mm	Perfil V07 Pesado
Ouro Perolizado	5100060	5100036
Azul Petróleo	5091056	5090829
Carbono	5091058	5090825
Cinza Sagrado	5091060	5090823
Rosa Glamour	5091062	5090821
Steel	5091065	5090827
Ultramarino	5091066	5090819
Aço Corten	5082275	5080331
Grafite	5082271	5080327
Rosé	5082273	5080329
Jateado	5056937	5058278
Bronze	5060317	5058282
Inox	5060315	5058280
Preto Fosco	5073684	5062369
Branco Fosco	5073682	5062367
Fendi	5073690	5062345
Branco Brilhante	5073688	5062347
Preto Brilhante	5073692	5062349
Branco TX	5073686	5067456

### LANÇAMENTO



Esquadreta Pesada Leo de 41mm para Perfil de Vidro com gabarito 5095109



Esquadreta Pesada Leo de 41mm para Perfil de Vidro sem gabarito 5095110



Baguete Adesiva para Perfis de Vidro 5059468



# M01

Para combinar com qualquer ambiente.



Cor	Perfil 15mm	Perfil 18mm
Jateado	5008455	5008456
Bronze	5071741	5071731
Inox	5071739	5071729
Preto Fosco	5071747	5071737
Branco Fosco	5071745	5071735

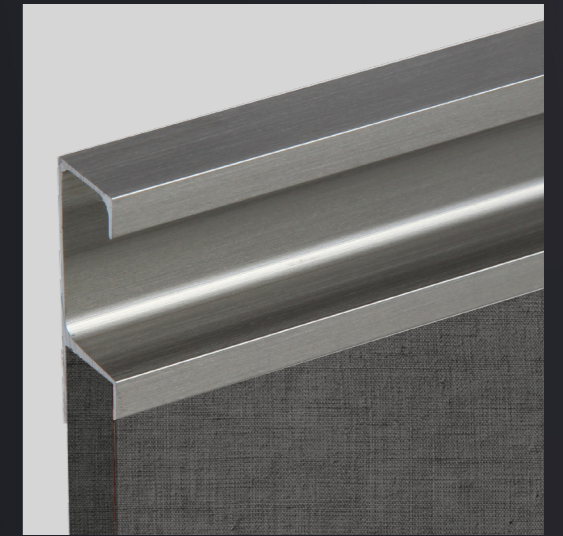

# M03

Delicadeza no acabamento.

O rasgo no MDF deve ser feito na serra esquadrejadeira.



Cor	Perfil 18mm
Jateado	5008457
Inox	5071775

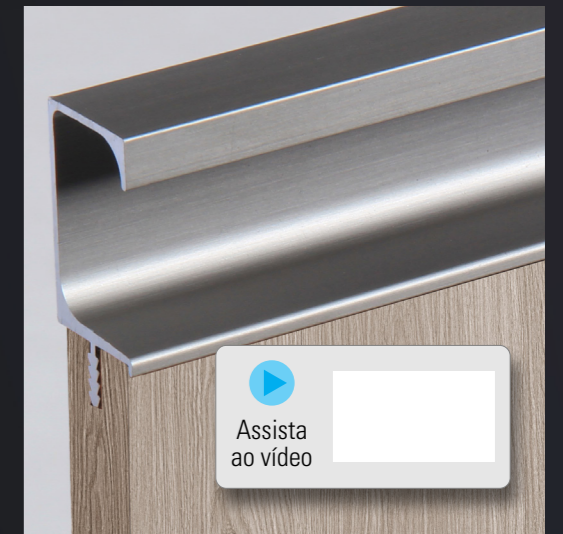

# M04

Delicadeza no acabamento da tampa vazada.

O rasgo no MDF deve ser feito na serra esquadrejadeira.



Cor	Perfil 18mm	Tampa Slim	Tampa Fechada
Jateado	5056474	5063214	5057310
Inox	5056476	5063220	-

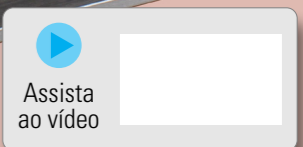

O mix completo de cores está disponível na plataforma

**promob**  
software solutions  
A 2020 Company

# M02PB

## Pegada Baixa

Aplicação nos projetos mais variados com melhor custo-benefício.

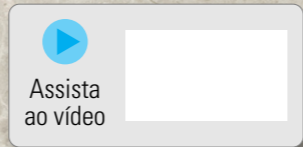

Pode ser aplicado sem tampa ou com a tampa de encaixe sem furação.



Perfil M02 Pegada Baixa



Tampa Vazada para Perfil M02 Pegada Baixa

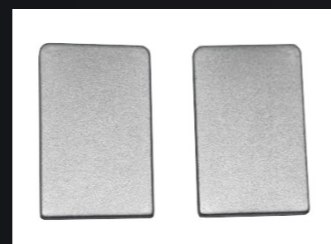

Tampa Fechada para Perfil M02 Pegada Baixa

Cor	Perfil 15mm	Perfil 18mm	Tampa Fechada 15mm	Tampa Fechada 18mm	Tampa Vazada 15mm	Tampa Vazada 18mm
Jateado	5068677	5068679	5070308	5070309	5070310	5070311

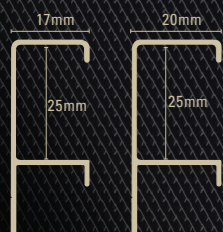

# M07

## Qualidade e beleza no acabamento dos móveis.

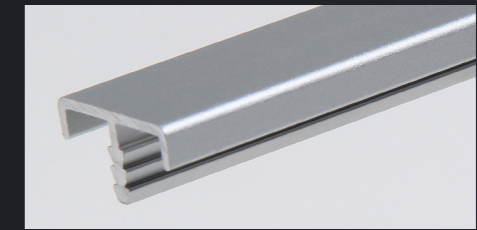

O rasgo no MDF deve ser feito na serra esquadrejadeira.



Cor	Perfil 18mm
Jateado	5056941

# M11

## Ótima pegada com desenho discreto e personalidade.

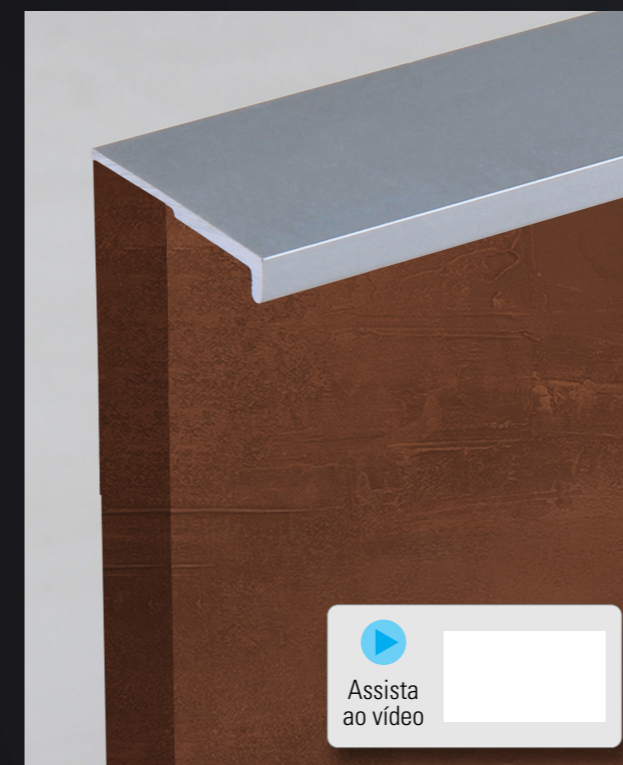

O rasgo no MDF deve ser feito na serra esquadrejadeira.



Cor	Perfil 18mm
Jateado	5056516

O mix completo de cores está disponível na plataforma

**promob**  
software solutions  
A 2020 Company

# V08

Conceito minimalista menos alumínio aparente.



Perfil V08 com aplicação do perfil M3000



## Harmonize o perfil V08 com o perfil M3000

V08, um perfil desenvolvido para ser utilizado com espelho ou vidro pintado de 4mm, deixando menos alumínio aparente.

O Perfil M30 com sua tampa slim é uma excelente opção de puxador para esse perfil.



Cor	Perfil 4mm
Jateado	5058684
Bronze	5058680
Inox	5058682



Recomendamos a fixação do espelho ou do vidro com a Cola Tudo Transparente Leo 260g (5071154).

### LANÇAMENTO



Esquadreta Pesada Leo de 41mm para Perfil de Vidro com gabarito 5095109



Esquadreta Pesada Leo de 41mm para Perfil de Vidro sem gabarito 5095110



Baguete Adesiva para Perfis de Vidro 5059468

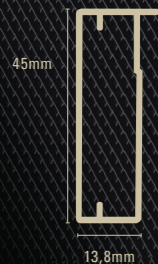

# M10

Perfil discreto que valoriza o desenho do móvel.



Assista ao vídeo



O rasgo no MDF deve ser feito na serra esquadrejadeira.

Cor	Perfil 18mm
Jateado	5056514



# M09

A sutileza deste Perfil valoriza as características do móvel, tornando-o mais leve e delicado.



Assista ao vídeo



O rasgo no MDF deve ser feito na serra esquadrejadeira.

Cor	Perfil 25mm
Jateado	5056512



O mix completo de cores está disponível na plataforma

**promob**  
software solutions  
A 2020 Company

# V09

Para portas até 0,80 x 2,80m.



## Harmonize o perfil V09 com o perfil M3000

O Perfil M30 com sua tampa slim é uma excelente opção de puxador para esse perfil.



Cor	Perfil 6mm
Bronze	5062331
Inox	5062327
Jateado	5062329

Recomendamos a fixação do espelho ou do vidro com a Cola Tudo Transparente Leo 260g (5071154).



### LANÇAMENTO



Esquadreta Pesada Leo de 41mm para Perfil de Vidro com gabarito 5095109



Esquadreta Pesada Leo de 41mm para Perfil de Vidro sem gabarito 5095110



Baguete Adesiva para Perfis de Vidro 5059468



# V10

Um perfil para ser embutido na porta de alumínio.



## Perfil V10 aplicado sobre o perfil V07 (Pesado)

Perfil V07 (Pesado)

Perfil V10

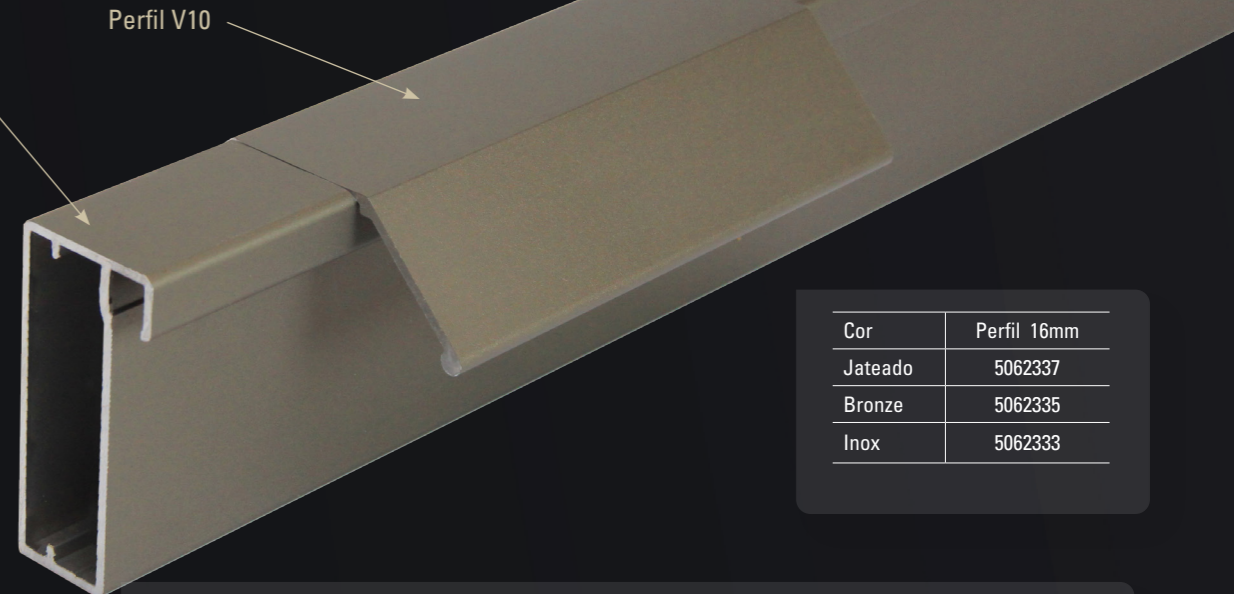

Cor	Perfil 16mm
Jateado	5062337
Bronze	5062335
Inox	5062333

## Harmonize o perfil V10 com o perfil V07

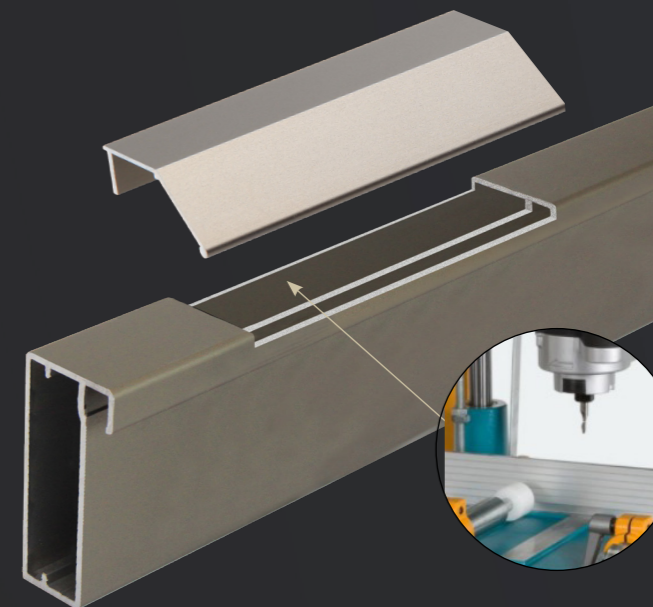

O rasgo no Perfil V07 para encaixe do Perfil V10 deve ser feito com um pantógrafo (equipamento utilizado na usinagem de perfil de alumínio).



### LANÇAMENTO



Esquadreta Pesada Leo de 41mm para Perfil de Vidro com gabarito 5095109



Esquadreta Pesada Leo de 41mm para Perfil de Vidro sem gabarito 5095110



Baguete Adesiva para Perfis de Vidro 5059468

O mix completo de cores está disponível na plataforma

**promob**  
software solutions  
A 2020 Company



# SISTEMA PERFIL PRATELEIRA



Infinitas possibilidades em um único sistema

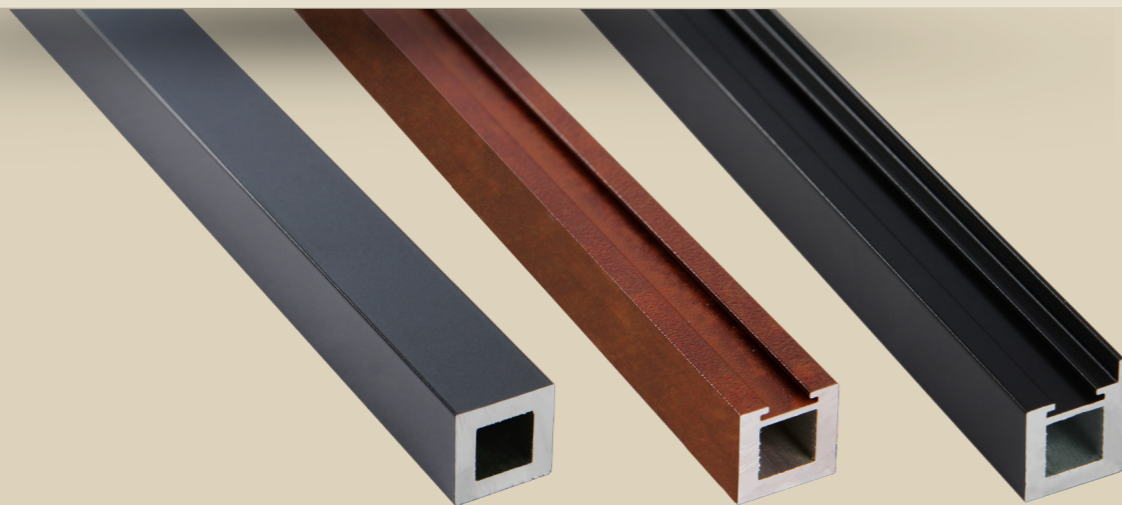

MV40

MV41

V42



www.leomadeiras.com.br

## PERFIS

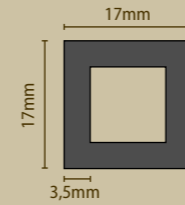

### MV40

#### Tubo

Ideal para estruturas em geral

5099994 - Ouro Perolizado  
5078627 - Grafite  
5078625 - Rosé  
5078629 - Aço Corten  
5078623 - Preto Fosco

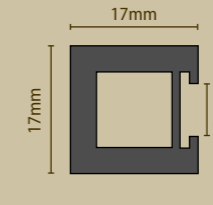

### MV41

#### Tubo Led

Ideal para estruturas em geral, com uso da fita de Led

5099996 - Ouro Perolizado  
5078635 - Grafite  
5078633 - Rosé  
5078637 - Aço Corten  
5078631 - Preto Fosco

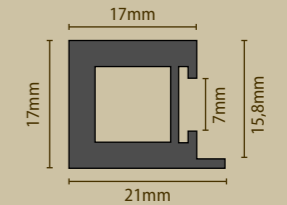

### V42

**Tubo Led com Apoio**  
Ideal para base de vidro

5099998 - Ouro Perolizado  
5078643 - Grafite  
5078641 - Rosé  
5078645 - Aço Corten  
5078639 - Preto Fosco

## ACESSÓRIOS



### Conector Travessa

5078647 - Pacote c/ 8 unidades e 16 Parafusos Philips M4x8mm



### Conexão 45° Dupla

5078649 - Pacote c/ 2 unidades e 4 Parafusos Philips M4x8mm



### Conexão 45° Tripla

5080632 - Pacote c/ 2 unidades e 6 Parafusos Philips M4x8mm

## ACESSÓRIOS



### Gabarito

5102771 - Pacote c/ 1 unidade



### Sapata Plástica

5078621 - Pacote c/ 4 unidades



### Fixa Teto

5078620 - Pacote c/ 4 unidades e 4 Parafusos Philips M4x8mm



### Emenda

5078648 - Pacote c/ 2 unidades e 4 Parafusos Philips M4x8mm

## EQUIPAMENTOS NECESSÁRIOS

- 5051902 Broca Aço Rápido 5mm Makita
- 5051907 Broca Aço Rápido 8mm Makita
- 5057002 Escareador Perfil Alumínio 8x3,2xH8mm Metali
- 5080974 Vira Macho T 1/4-1/2" (3-6mm)x90mm 954
- 5080975 Macho Manual HSS M 6x1mm c/ 3 MA/MG Vonder
- 5085668 Serra 250x2,8x30x80 Alumínio FR23A001M Freud
- 5085669 Serra 300x2,8x30x96 Alumínio FR28A001M Freud
- 5068153 Fita Led Fria+Fonte c/ Silicone 5000
- 5068152 Fita Led Quente+Fonte c/ Silicone 5000

## TAPA-FUROS

- Aço Corten ● 5071234 Steel Ess 13mm c/ 50
- Grafite ● 5031727 Ônix Silk 13mm c/ 50
- Rosé ● 5071226 Bolonha 13mm c/ 50
- Preto ● 5059445 Ônix Cetin 13mm c/ 50

**Tapa-Furos: utilizado para ocultar o parafuso da instalação, oferecendo um melhor acabamento.**

O mix completo de cores está disponível na plataforma

**promob**  
software solutions  
A 2020 Company

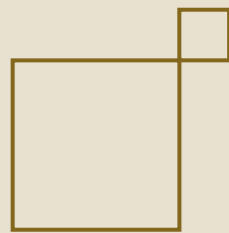

SISTEMA PERFIL PRATELEIRA

Inspire-se !



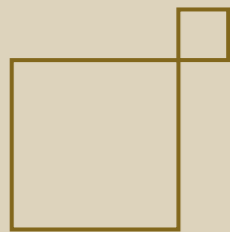

## SISTEMA PERFIL PRATELEIRA

# Instruções de Usinagem e Montagem

Amigo Profissional, o Sistema Perfil Prateleira oferece, com poucos acessórios, infinitas possibilidades para criar estantes personalizadas. Agora, sua criatividade não tem limites!

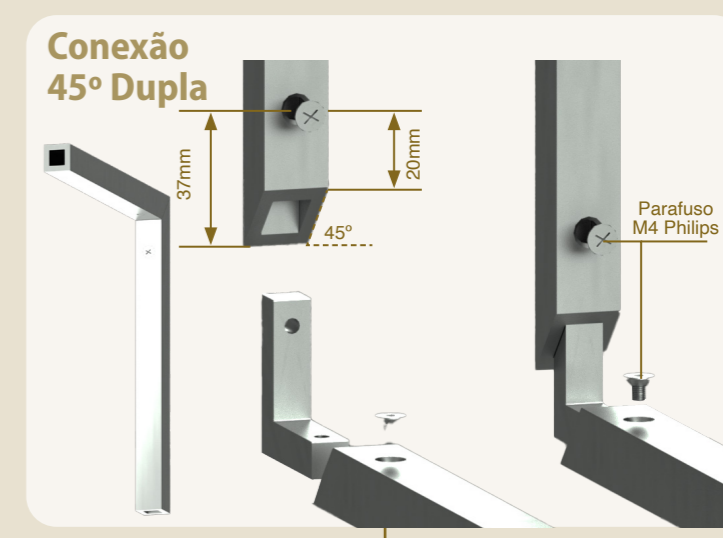
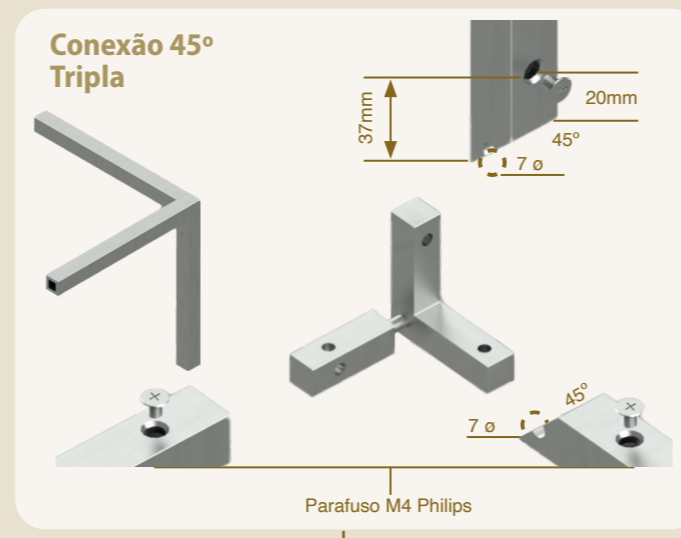
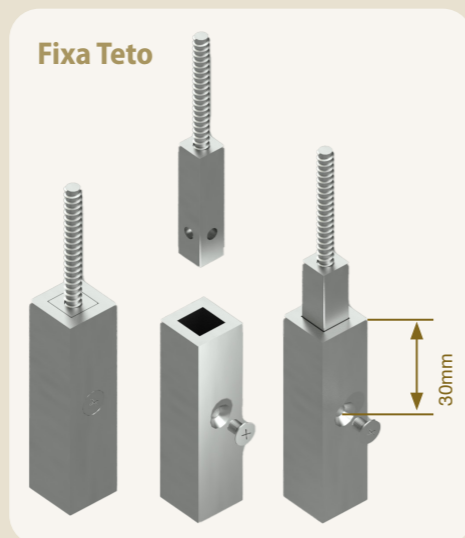
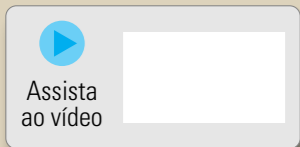

Para utilização do parafuso M4 Philips, usar broca de 5mm para furo passante e broca de 8mm ou escareador para o rebaixo de 8mm.

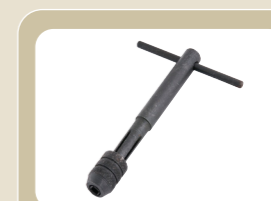
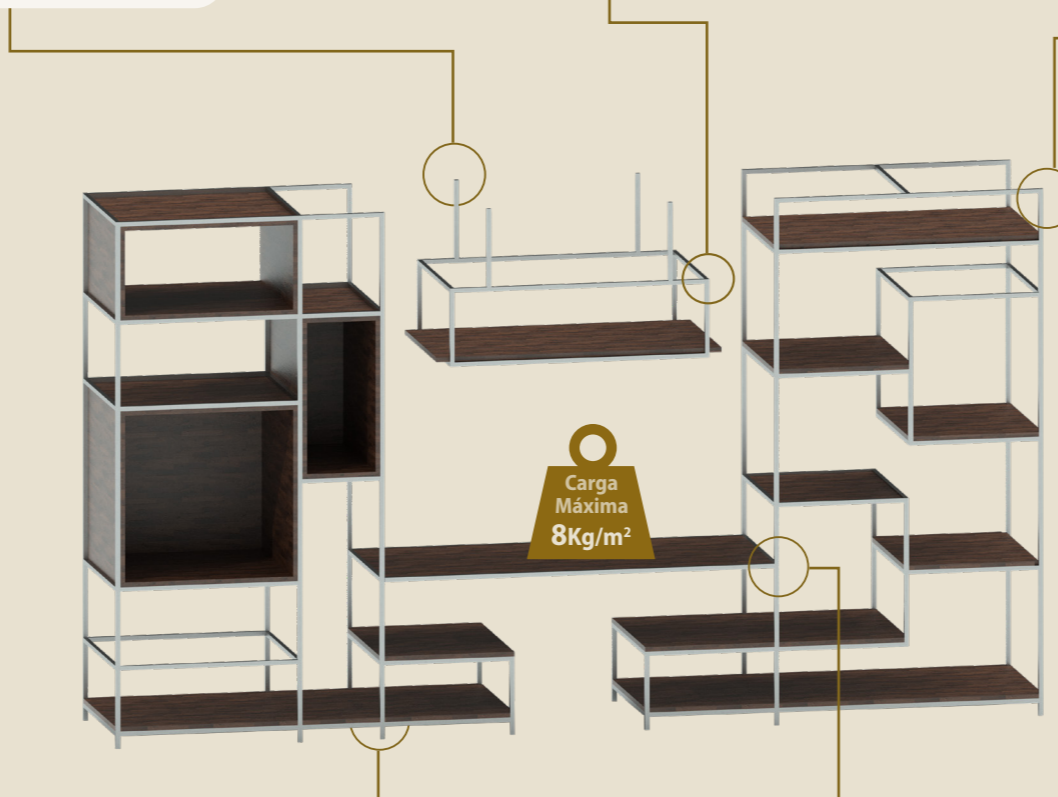

Vira Macho T 1/4-1/2" (3-6mm)x90mm 954 5080974



Macho Manual HSS M 6x1mm c/ 3 MA/MG Vonder 5080975

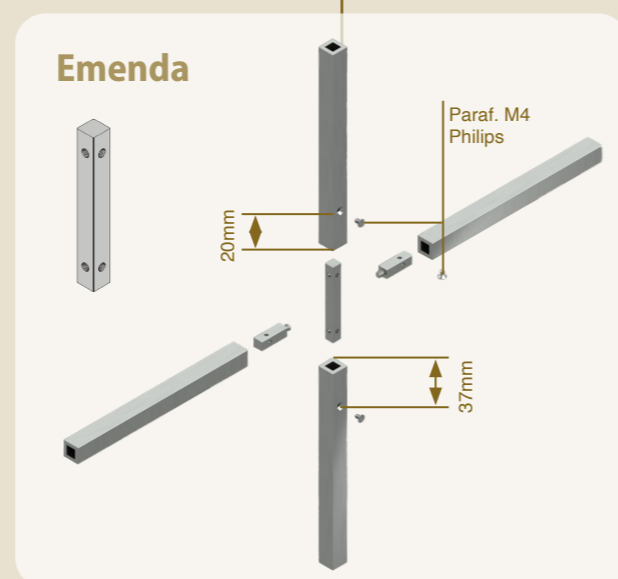

Para efetuar a fixação do conector travessa será necessário utilizar os seguintes materiais:

- 5051902 - Broca Aço Rápido 5mm Makita 5051907
- 5080974 - Vira Macho T 1/4-1/2" (3-6mm)x90mm 954
- 5080975 - Macho Manual HSS M 6x1mm c/ 3 MA/MG Vonder

Faça um furo com a broca de 5mm com mais precisão possível, utilize o conjunto de macho manual, começando primeiro com o macho de marca com um risco, prenda no vira macho e faça o movimento rosquear e desrosquear até chegar ao fim do curso. Após esta operação, repita o processo com o macho de marca com dois riscos e faça a mesma operação conforme dito anteriormente. Para finalizar a rosca, utilize o macho sem marca de risco.

Dica: para auxiliar no processo manual da rosca, utilize álcool em líquido ou em gel para lubrificar e refrigerar.



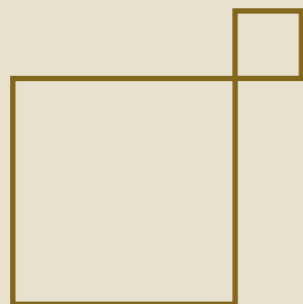

# SISTEMA PERFIL PRATELEIRA

Exemplo de montagem de prateleira básica

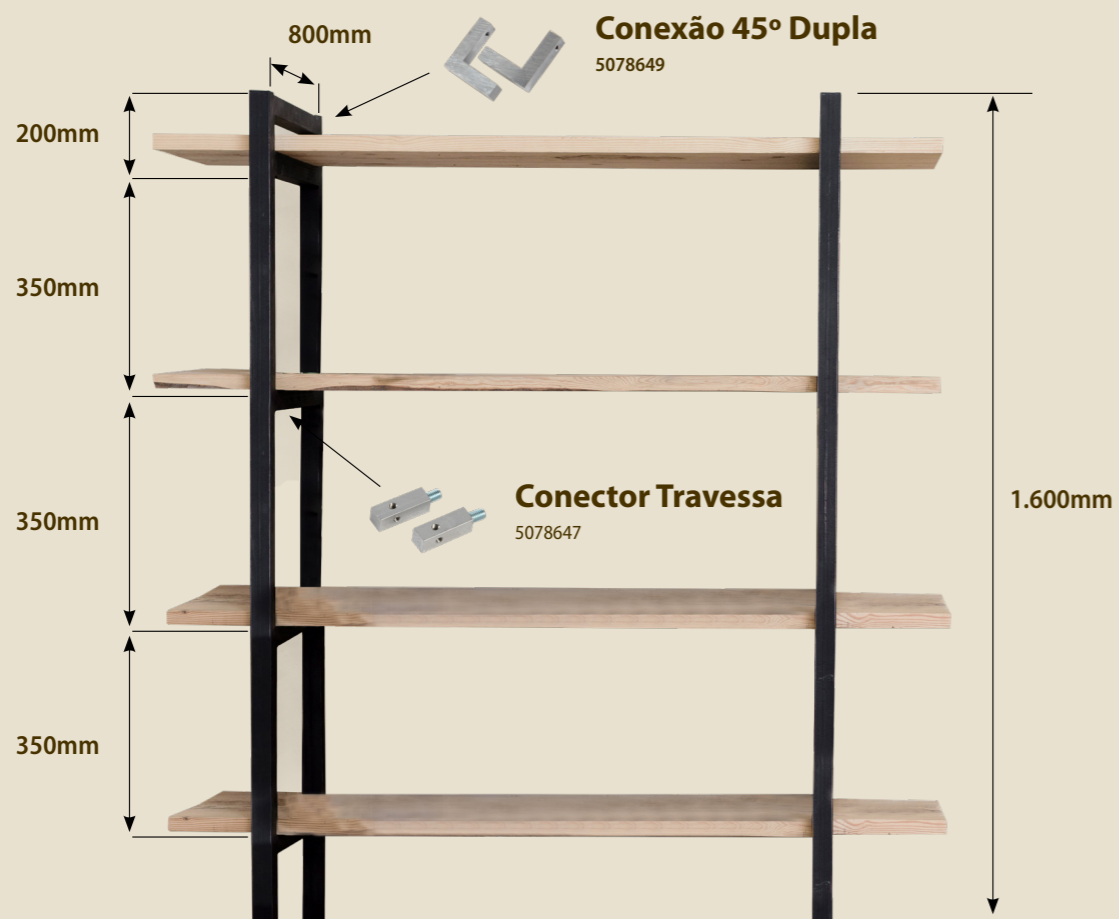

## Identificação de Montagem

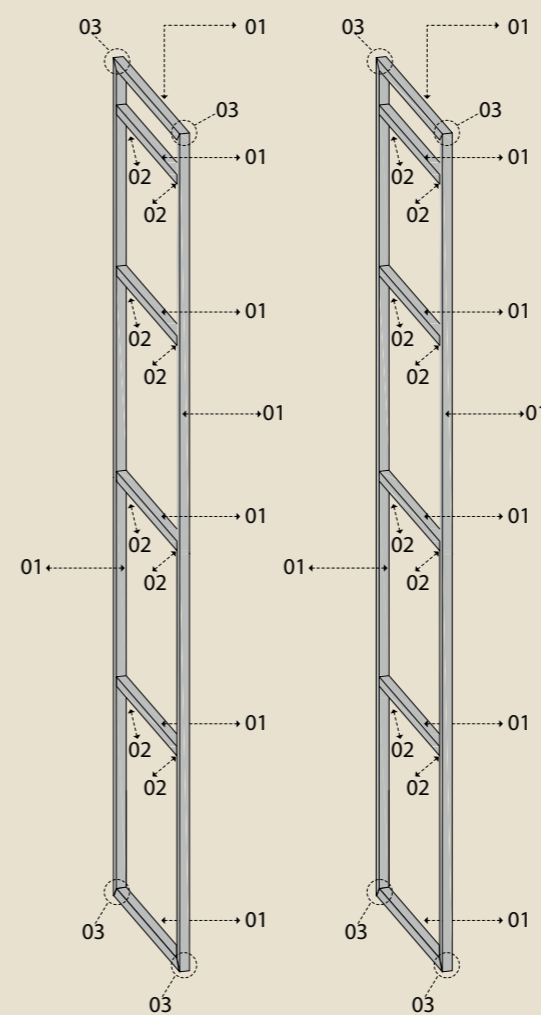

## Simulação de Montagem

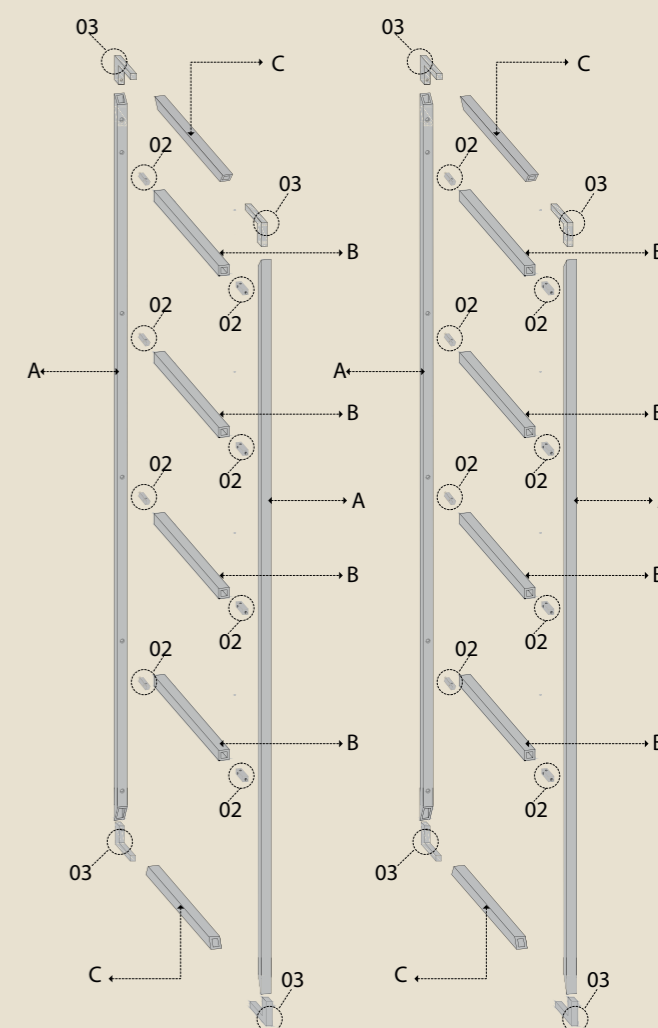

Item	Código	Descrição	Quantidade
01	5078623	Perfil MV40 Preto Fosco	7 barras com 3m
02	5078647	Conector Travessa	16 unidades
03	5078649	Conexão 45° Dupla	8 unidades

Peça	Quantidade	Orientação de Corte
A	4	45° / 45°
B	8	90° / 90°
C	4	45° / 45°

## Inspire-se



# TRILHOS LEO

Na Leo você encontra os principais trilhos disponíveis em todas as cores dos perfis Leo

Tabela de similaridade com os trilhos do mercado

Modelo Leo	Rometal	RFC
TLSD26	RM030	RFC3013
TLSD28	RM025	RFC3010
TLSD32	RM038	RFC3032
TLID29	RM022	RFC3027
TLID34	RM023	RFC3028
TLID39	RM034	RFC3047
TLS 13,5	RM018	RFC3040
TLS 13	RM021	RFC3039

	Trilho Superior			Trilho Inferior		
	26mm	28mm	32mm	29mm 39mm	34mm 44mm	37,8mm 57mm
	TLSD26	TLSD28	TLSD32	TLID29	TLID34	TLID39
Azul Petróleo	5092694	5092706	5096318	5092718	5092730	5096330
Carbono	5092700	5092712	5096314	5092724	5092736	5096326
Cinza Sagrado	5092698	5092710	5096312	5092722	5092734	5096324
Rosa Glamour	5092690	5092702	5096308	5092714	5092726	5096320
Steel	5092696	5092708	5096310	5092720	5092732	5096322
Ultramarino	5092692	5092704	5096316	5092716	5092728	5096328
Aço Corten	5090391	5090401	5090415	5090431	5090443	5090455
Grafite	5090393	5090403	5090417	5090433	5090445	5090457
Rosé	5090395	5090405	5090419	5090435	5090447	5090459
Jateado	5090399	5090413	5090429	5060994	5060995	5061000
Branco Brilhante	5063293	5090407	5090423	5090437	5090449	5063290
Branco Fosco	5059501	5059502	5059505	5059500	5059503	5059504
Branco Texturizado	5090397	5090409	5090425	5090439	5090451	5090461
Bronze	5059513	5059514	5059517	5059512	5059515	5059516
Fendi	5063295	5086979	5090421	5086981	5086977	5063291
Inox	5059477	5059478	5059481	5059476	5059479	5059480
Preto Brilhante	5063294	5090411	5090427	5090441	5090453	5063292
Preto Fosco	5059489	5059490	5059493	5059488	5059491	5059492

## EMBALAGEM DOS PERFIS DE ALUMÍNIO

Embalagem exclusiva. Protege o perfil até a entrega do móvel no cliente.

- A anodização evita que o perfil descasque e oxide.
- No manuseio não ficam marcas dos dedos.
- A limpeza é simples, apenas com sabão neutro.

Com a nova embalagem, o marceneiro tem uma proteção a mais, o filme azul protetor, para evitar riscos ou pequenos danos no perfil, garantindo sua integridade até a montagem final.



1. Embalagem transparente para ajudar na identificação do perfil.



2. Para utilizar, retire a parte branca da proteção da embalagem, preservando o filme azul protetor.



3. Corte o perfil no tamanho necessário para seu projeto, sem retirar o filme azul protetor.



4. Instale o perfil e retire o filme azul protetor somente após a instalação do móvel, na casa do cliente.

## DICAS

### Equipamentos para instalação dos perfis

#### Corte de Perfis de Alumínio

Serra Meia-Esquadria 10" MLS100 Makita  
110V - 5002089  
220V - 5002090



Serra FR23A001M Freud  
250x2,8x30x80 Alumínio Freud  
5085668



#### Dicas

- Usar o disco de corte correto: Freud Reto Trapezoidal.
- Deve ser cortado em serra de esquadria ou meia-esquadria, em 90° ou 45°, dependendo da aplicação.
- O uso da serra adequada garante um acabamento de qualidade.

#### Corte de MDF a 45° ou 90°

Serra Leo Black Storm 250x2,8x30x80 Dentes Alternados p/ MDF 5058240

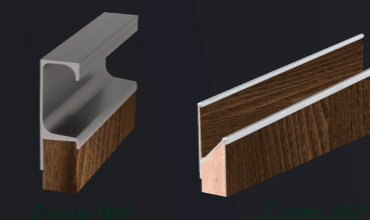

#### Dicas

- O corte do MDF em 45° ou 90° deve ser feito preferencialmente numa Serra Esquadrejadeira.
- Usar o disco de corte indicado.

#### Rebaixo de MDF

Tupia Manual 3709 06mm 1/4" Makita  
110V - 5000317  
220V - 5000318



#### Dica

O rebaixo deverá ser feito com tupia manual ou estacionária.

#### Esquadrejadeira SEL1900i

Monofásico - 5063704  
Trifásico - 5063705

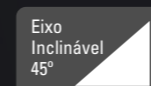

#### Montagem de Perfis com Parafuso

Furadeira Parafusadeira LCT204 12V Makita 5053135



Parafuso 5066053



Broca Dobradiça 35mm H10mm p/ Alumínio 5056993



#### Dicas

- Todos os perfis que têm a guia (marcação) podem ser fixados por parafuso.
- Usar parafuso de 3,5x12 tanto para a chapa de 15mm como para a de 25mm.
  - O número de parafusos dependerá da avaliação do profissional, ou seja, pode variar de caso para caso.

#### Montagem de Perfis com Adesivo

Cola Tudo Transparente Leo 5071154



Pistola de Aplicação de Silicone Profissional Ferrari 5057131

#### Dicas

- Os perfis também podem ser instalados com o adesivo de montagem PL500.
- Agarre imediato.
  - Não escorre.
  - Possibilidade de ajustes de até 10 minutos.
  - Cura total: 24 horas.

O mix completo de cores está disponível na plataforma

**promob**  
software solutions  
A 2020 Company

[www.experienciasleo.com.br](http://www.experienciasleo.com.br)

[www.leomadeiras.com.br](http://www.leomadeiras.com.br)



Rede

Leo